

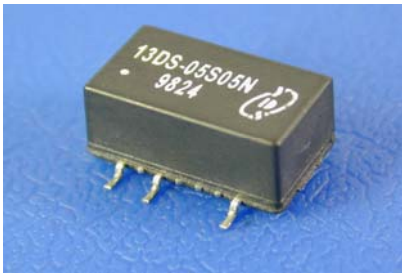

1000Vdc Isolation 1 Watt Single Output Surface Mount Dc-Dc Converter



FEATURES:

- Small Footprint
- 14PIN SMD Package
- High Efficiency up to 80%
- Unregulated Output Types
- High Power Density
- No External Component Required
- Operating Temperature: -40°C TO +85°C
- Industry Standard Pinout



Specifications typical at TA=25°C, nominal input voltage and rated output current unless otherwise specified

Part Number	Output Voltage	Output Current	Efficiency
	Vdc	mA	% TYP
13DS-XXS03NNL	3.3	303	65
13DS-XXS05NNL	5	200	70
13DS-XXS09NNL	9	110	75
13DS-XXS12NNL	12	84	78
13DS-XXS15NNL	15	67	80

Note: 1. "XX" Is Input Voltage: 03=3.3Vdc, 05=5Vdc, 09=9Vdc, 12=12Vdc, 15=15Vdc.
 2. The input voltage increases, there will be an increase in efficiency.

Input Specifications

Parameters	Conditions	Min	Typ	Max	Units
Voltage Tolerance	Vo, Io Nom			±5	%
Filter	Capacitor				

Output Specifications

Parameters	Conditions	Min	Typ	Max	Units
Voltage Tolerance	100% full load			±5	%
Short Circuit Protection	Short Term			1 Sec	
Line Regulation	For 1.0% OF Vin		1.2		%
Load Regulation	3.3V(10% To 100% F.L)		15		%
Load Regulation	5V,9V(10% To 100% F.L)			15&9.0	%
Load Regulation	12V,15 V(10% To 100% F.L)			7.5&7.0	%
Ripple & Noise	BW=DC To 20MHZ			100	mVp-p
Transient response setting time	50% load step change		350		us

General Specifications

Parameters	Conditions	Min	Typ	Max	Units
Isolation Resistance	500Vdc	1000			MΩ
Switching Frequency	Full load, nominal input		100		KHz
Operating Temperature		-40		+85	°C
Humidity	Non Condensing			95	%
Cooling	Free air Convection				
Case material	DAP				
MTBF	MIL-HDBK-217F@25°C	3500000			Hours
Weight			1.0		g
Dimensions		12.7X7.6X6.25			mm



Temperature Derating Graph

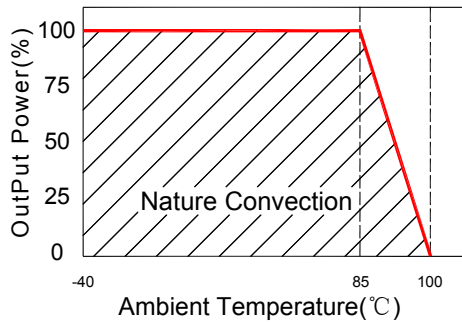

Tolerance Envelope Graph

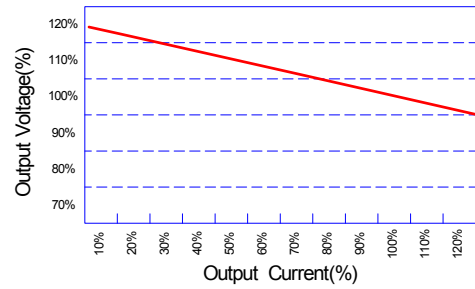

Recommended Test Circuit

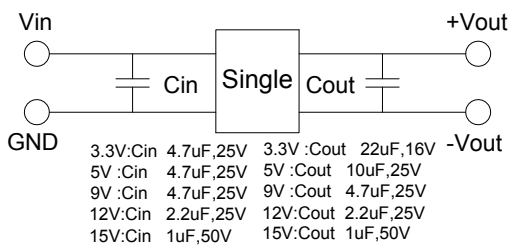

Part Number

13DS - 05 S 05 N NL
 A B C D E F

A: Series
 B: Input Voltage
 C: Single(S)
 D: Output Voltage
 E: Unregulated(N)
 F: RoHS Version

Markings and Dimensions

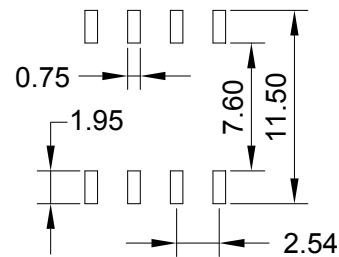
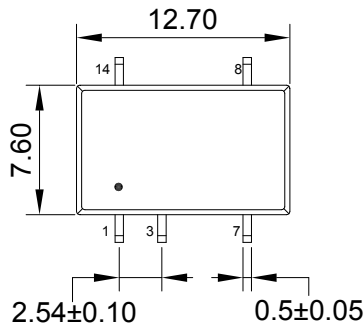

SUGGESTED PAD LAYOUT

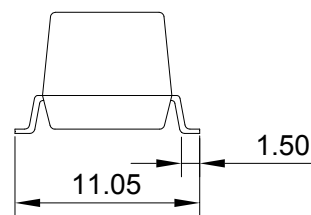
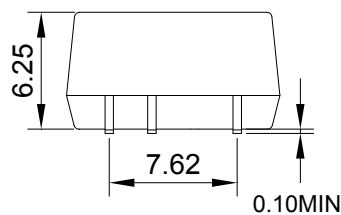

UNIT : mm Unless otherwise specified, all tolerances are ±0.25

PIN Connection

Pin	1	3	7	8	14
Single	-Vin	+Vin	-Vout	+Vout	NC